

Fuji Medium-voltage IGBT Inverters

FRENIC4600FM5e



FRENIC4600FM5e

AC Adjustable Speed Drive

Fuji Electric Co., Ltd.

Environment-friendly inverters.

Fuji medium-voltage IGBT inverter FRENIC4600FM5e is used for direct variable-speed control of medium-voltage motors, and greatly raises the efficiency and power factor, stabilizes motor operation and conserves energy.

Compact design for space saving

- The industry's smallest-class inverter achieved by significant panel size reduction

Ideal inverter for power sources and motors

- The multi-phase diode rectifier system reduces harmonics on the power source side.
- Due to the use of Fuji Electric's unique multi-level PWM control system, the switching surge is reduced and existing motors (standard ones) can be operated.

High-efficiency and high-power factor

- The use of a multi-phase diode, full-wave rectifier provides a high-power factor (95% or more) on the power source.
- The elimination of output transformers for operation has improved total efficiency (approx. 97%).
- Fuji Electric's original multi-level PWM control has reduced the IGBT switching loss.



10kV 1,200kVA

High-reliability

- Higher equipment reliability is achieved by reducing the number of inverter cells by using a single-phase, 3-level inverter, etc..
- Stable operation is maintained despite load fluctuations, by the simple sensor-less vector control function.
- The control device has a 32-bit MPU for quick response and high-accuracy.

Contributes to energy saving

- A substantial energy saving is achieved by variable-speed control of a square-law reduced torque load such as a fan or pump.

Vector control (option)

- Vector control with a speed sensor is available (as an option) for equipment having high speed and torque accuracy requirements.

Easy maintenance

- The inverter is air-cooled, requiring no cooling water.
- Start/stop operation, parameter setting, fault display and data monitoring are performed from the touch panel with simple loader functions.
- Simple, built-in auto-tuning functions facilitate testing and adjustment.
- Fault diagnoses are easily performed.
- A dry-type input transformer is adopted.

High-reliability and simple-maintenance inverters utilizing the latest power electronics such as 3-level inverter, mounting of special MPU and no need for harmonic filter/power-factor regulating capacitor.

Cooling fan

- Air-cooled inverters make maintenance easy.

Input multiplex-winding transformer

- Harmonic current on the power source side is low due to a multiplex configuration of the secondary winding.
- An equivalence of 36-phase rectification is effected, so harmonic current satisfies the standard level of IEEE.
- Harmonic filters and power factor improving capacitors are not needed.
- Because a dry-type input transformer is used in the panel, external cabling work between the input transformer and inverter panel is no longer necessary.

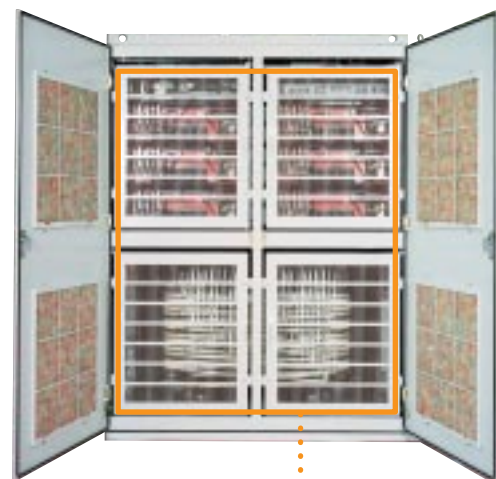

When requested, protection covers can be provided inside the inverter panel (as an option). Protection covers will protect from unexpected contact with live metal parts of the main circuit.

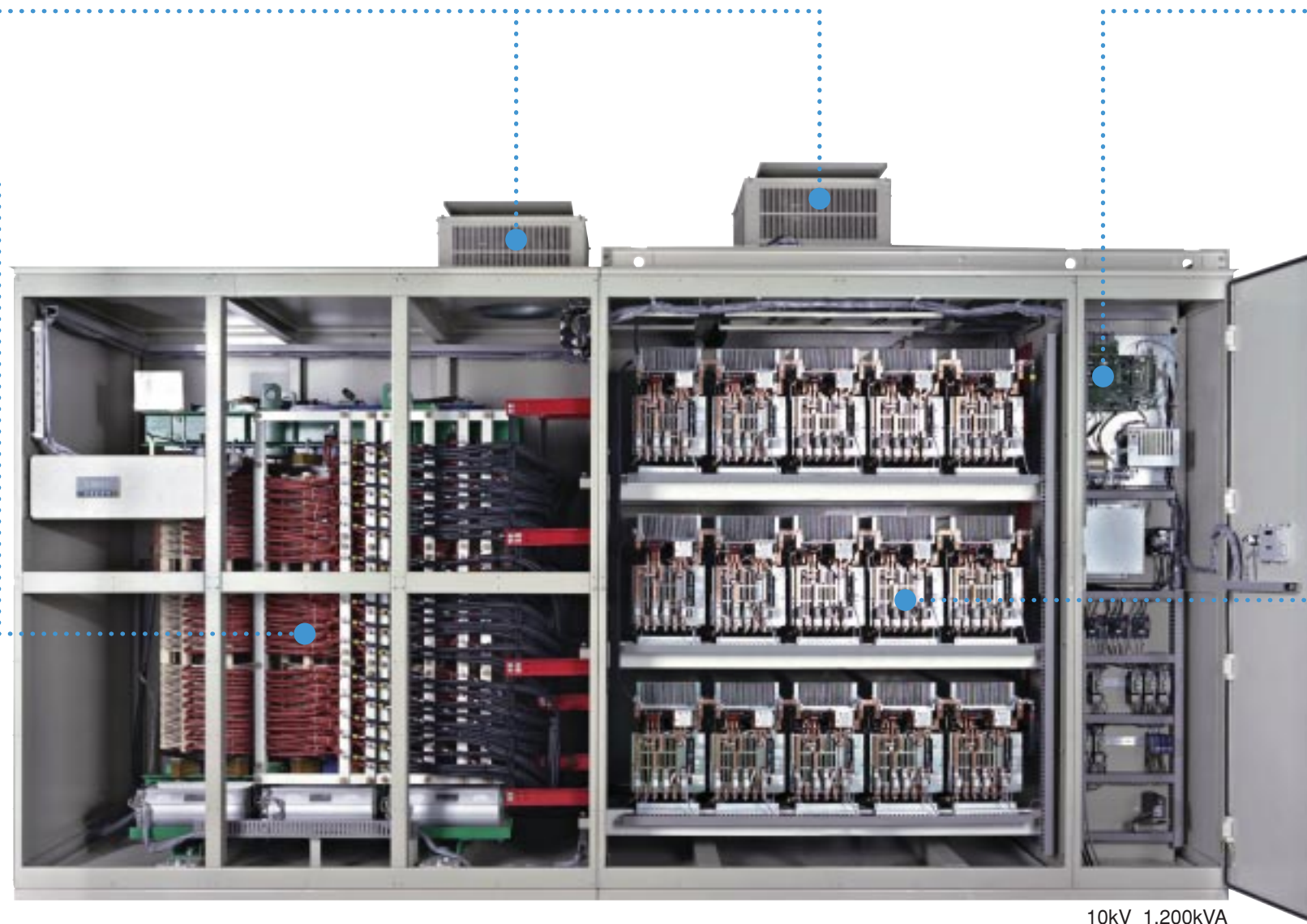

Master control PC board

- Mounting of a 32-bit MPU, and a special MPU in the voltage and current detection system offers a quick response and high accuracy.
- Incorporation of a simple sensor-less vector control function enables inverters to maintain stable operation irrespective of load fluctuation even without a speed sensor.

Inverter cell

- The number of inverter cells has been substantially reduced by adopting a single-phase, 3-level inverter design.
- Each inverter cell alone can be replaced easily, because the controller, diodes, IGBT elements and DC intermediate capacitor are combined into an integral body.

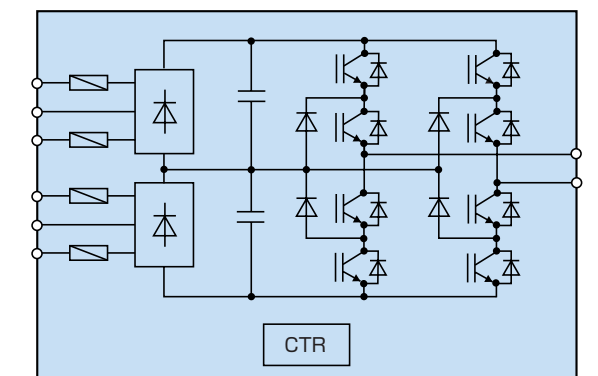

Clean power input

Substantial reduction of harmonic current on power source side

Due to progress in power electronics, semiconductors have recently been used for industrial electrical equipment and household electrical appliances in order to enhance convenience and ease of operation. However, due to harmonic currents generated from such equipment and appliances, the voltage of the power system is often distorted and many troubles occur in equipment connected to the power system. However, because the use of equipment containing power electronics will increase, measures for suppressing harmonics need to be improved.

FRENIC4600FM5e suppresses the harmonics by using a multi-phase diode rectification system (equivalent to 36-phase rectification), thereby substantially reducing the generation of harmonics in comparison with previous models.

The harmonic generation level stipulated in IEEE-519 (1992) is satisfied.

This inverter is ideal for power sources.

■ Current waveform on power source side

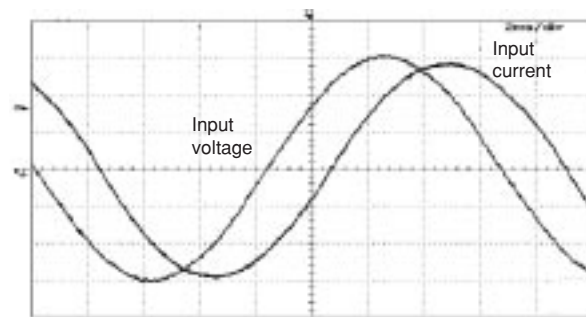

■ Harmonic current content

Order	5th	7th	11th	13th	17th	19th	23rd	25th	35th	37th
IEEE value [%]	4.00	2.86	1.83	1.49	1.14	1.02	0.87	0.80	0.80	0.80
Measured value (*) [%]	0.58	1.0	0.20	0.32	0.75	0.54	0.06	0.24	0.58	0.27

(*): Example value from our full load test

Total inverter efficiency as high as approximate 97%

- Because an output transformer is unnecessary, inherent losses are eliminated.
- Multi-level PWM control minimizes switching loss.
- Because the harmonic current on the power source side is reduced, the primary winding of the input transformer has a reduced loss due to the harmonics.

■ Total inverter efficiency curve (including input transformer)

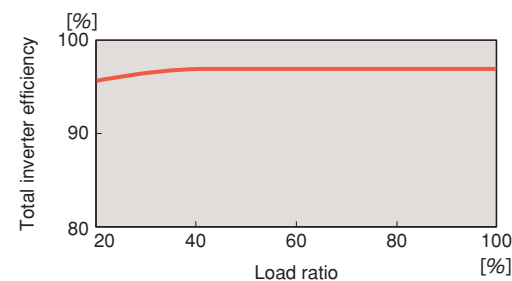

Source power factor as high as 95% or more

- Due to full-wave rectification with multi-phase diodes, operation is allowed with the source power factor (power factor on power source side) set at a high level.
- A phase advancing capacitor and a DC reactor for improving the source power factor are unnecessary.
- A smaller power capacity suffices for inverter operation.

■ Source power factor curve

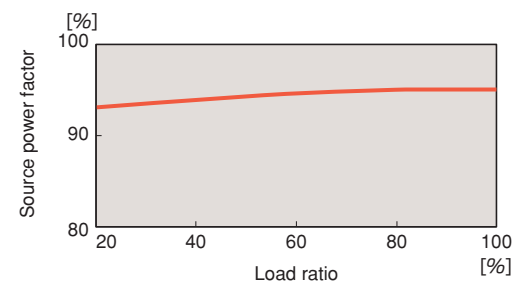

Note: The efficiency and power factor data on this page are calculated by assuming that a 315kW motor is operated at the rated speed with a 3.3kV-input, 390kVA-output inverter. The data on efficiency is obtained using Fuji Electric's standard 4-pole motor.

Friendly to machines

If a harmonic current component is contained in the inverter output current, a torque ripple occurs on the output shaft of a motor. A torque ripple means a change in rotational speed or a large vibration if the frequency of the torque ripple matches the natural frequency of the mechanical system and torque ripple is large.

In FRENIC4600FM5e, the harmonic component on the output side is extremely small due to the multi-level (max. 21 levels) PWM control and the main component of torque ripple is at around the carrier frequency (several kHz). Therefore, torque ripple hardly affects the machine side.

Friendly to motors

- The multi-level PWM control provides an almost sinusoidal output current waveform, thus reducing motor torque ripple.
- Because the output current is almost sinusoidal, a motor suffers less loss due to harmonics.
- The multi-level (max. 21 levels) PWM control minimizes switching surge and thereby reduces stress on the motor.
- There is no need to reduce motor capacity due to inverter drive.
- There is no need for special cables, etc. due to inverter drive.

- This inverter is applicable not only to a square-law reduced torque load, but also to a constant torque load such as an extruder.
- For driving a large-capacity motor in a system that has a small power capacity, voltage fluctuation, etc. due to the starting current of a motor will cause problems. However, because the starting current can be suppressed by the soft start of this inverter, operation can be performed.

— : output voltage waveform — : output current waveform

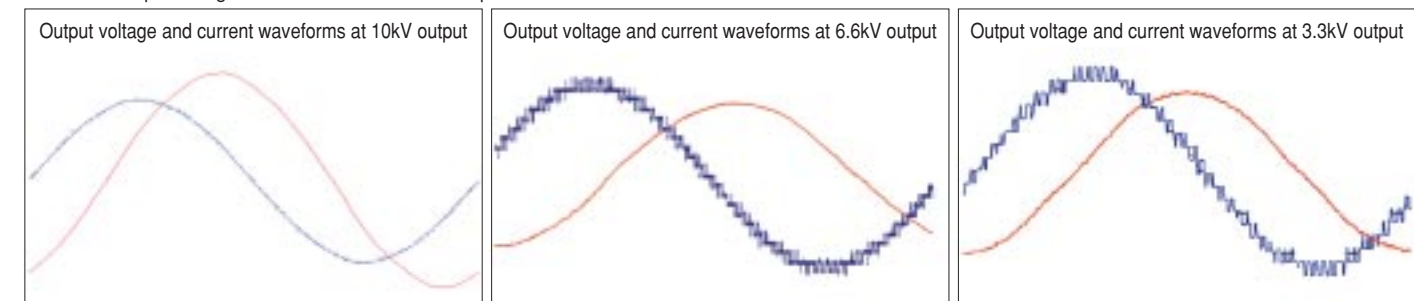

Note

Surge voltage and multi-level output

The output voltage waveform of a PWM inverter is a DC chopping voltage (called "pulse voltage = surge voltage") whose amplitude is determined by voltage E_d of the DC intermediate circuit. When this surge voltage of inverter output is applied to a motor through a cable, the voltage is reflected repeatedly between the motor terminal and inverter terminal. A sharp overvoltage higher than the inverter output voltage is thus generated at the motor terminal, which may cause dielectric breakdown of the winding.

Fuji Electric's medium-voltage inverter suppresses the DC intermediate voltage level so as to realize an output voltage waveform at 21 levels in the 10kV class, at 13 levels in the 6kV class and 9 levels in the 3kV class. As a result, the overvoltage generated at the motor terminal can be suppressed.

Output voltage waveform (21 levels) in 10kV class

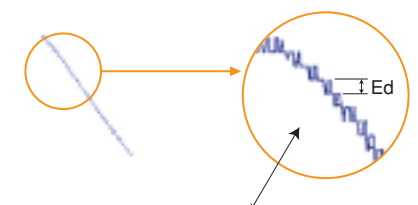

In the 10kV class Fuji Electric's medium-voltage inverter, the output voltage changes in 21 steps (corresponding to 21 levels) within 1/4 cycle. The voltage value of one step equals the DC intermediate circuit voltage E_d . Therefore, for the same voltage output, a larger number of steps means a smaller voltage value at one step. Thus, Fuji Electric's inverter can also reduce the surge voltage appearing at the motor terminal and thereby moderate the stress applied to the motor.

Main circuit configuration

Fig. 1 Main circuit configuration of 10kV type

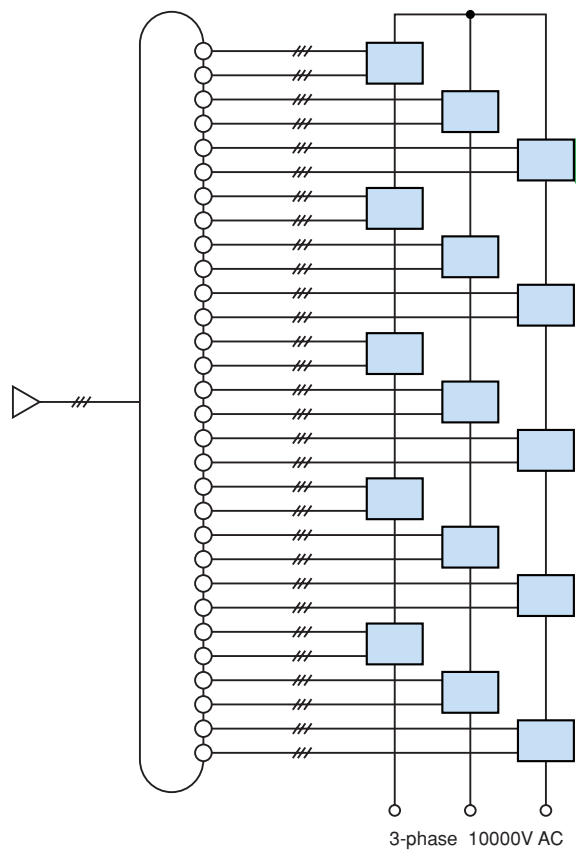

Principle of operation

FRENIC4600FM5e consists of an input transformer and 15 inverter cells in case of the 10kV type as shown in Fig. 1 (the 6kV type has 9 inverter cells and the 4.16 and 3kV types have 6 inverter cells.).

One inverter cell consists of a single-phase, 3-level inverter and can receive an output voltage of 1,155V.

As shown in Fig. 1, the 10kV type obtains a phase voltage of about 5,775V by connecting 5 inverter cells vertically and a

Fig. 3 3-level voltage output

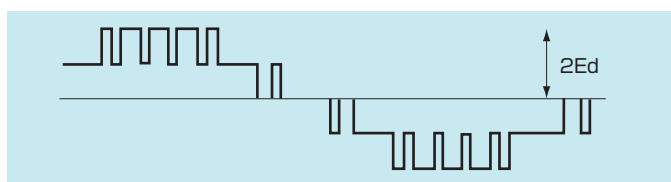

Ed: DC intermediate circuit voltage

Fig. 2 Internal configuration of inverter cell

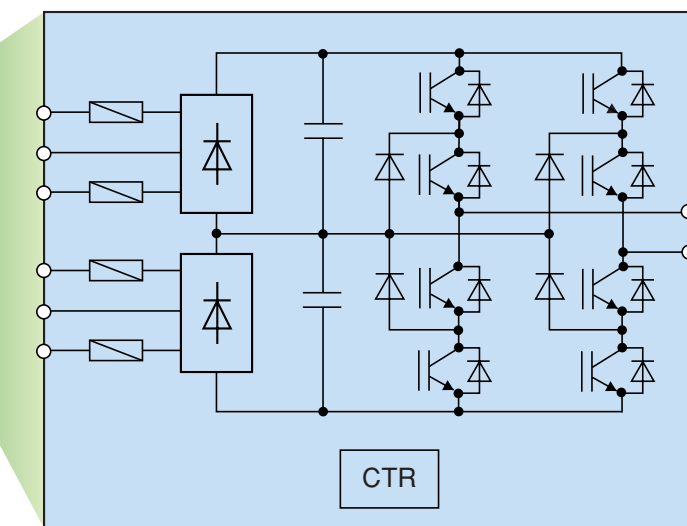

star connection of the vertical cell pairs can generate a line voltage of about 10,000V.

Use of the single-phase, 3-level inverter doubles the output voltage obtainable from one cell when compared with a single-phase, 2-level inverter. Therefore, an output voltage can be obtained by using a smaller number of inverter cells. (See Figs. 3 and 4.)

Fig. 4 2-level voltage output

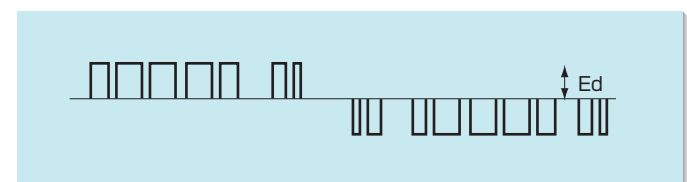

Commercial power supply bypass circuit/restarting function after momentary interruption

- Shockless switching between inverter operation and commercial power operation allowed by phase control according to system voltage. (See Fig. 5.) (Synchronizing/parallel off function: option)
An electric reactor must be installed on the output side of the inverter to enable this function.

- Changeover to the starting circuit by commercial power supply can be made by installing a bypass circuit (option) on the inverter output side.

In this configuration, motor drive power supply is duplicated, and changeover between commercial power supply and inverter operation is allowed for running a motor at the rated speed. (See Fig. 6.)

- In the event of a voltage drop due to a momentary power interruption, the operation processing pattern can be selected according to the application.

1. Selection of major fault at voltage drop due to momentary power interruption

The inverter is stopped in the major fault status and the motor is set in the free run status.

2. Selection of restart under free run (option)

Inverter operation is stopped and the motor is set in the free run status. Upon power recovery, the motor under deceleration in free run or under stop is automatically accelerated again through a speed search function.

3. Selection of continuing operation at voltage drop due to momentary power interruption (option)

Inverter operation is continued without setting the motor in the free run status even when a voltage drop due to a momentary power interruption occurs. As soon as line voltage is recovered, the motor is accelerated again back to the operating speed.

Notes:

- (1) A voltage drop due to a momentary power interruption will be detected at 85% or less of the rated voltage.
- (2) Operation can be continued within 300ms at a voltage drop due to a momentary power interruption (option).

Fig. 5 Synchronizing/parallel off waveform

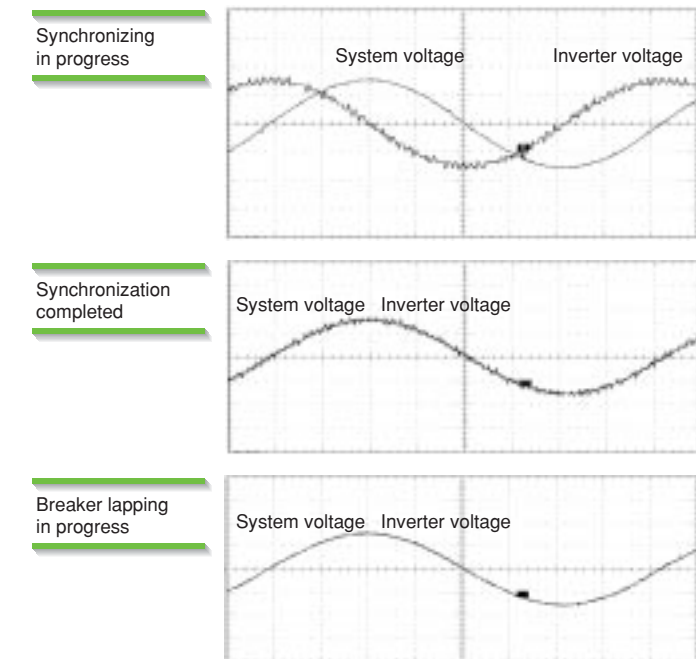
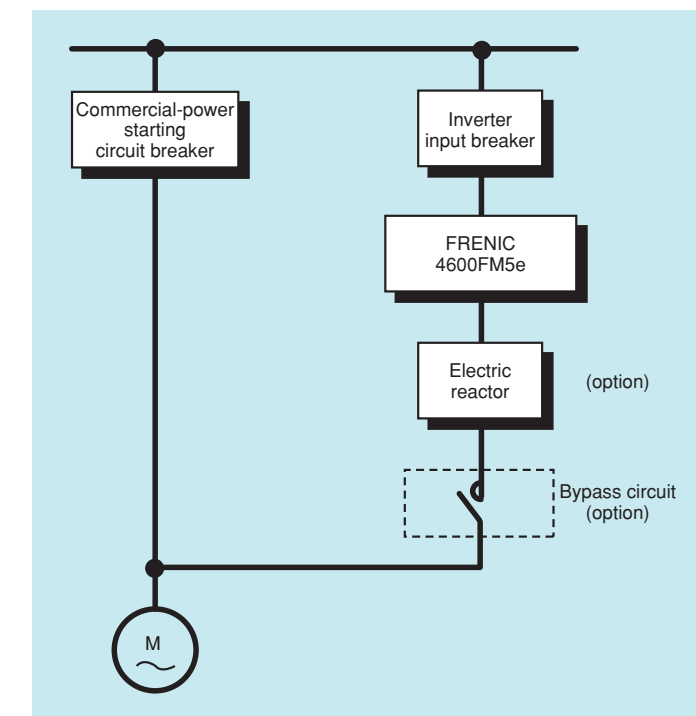
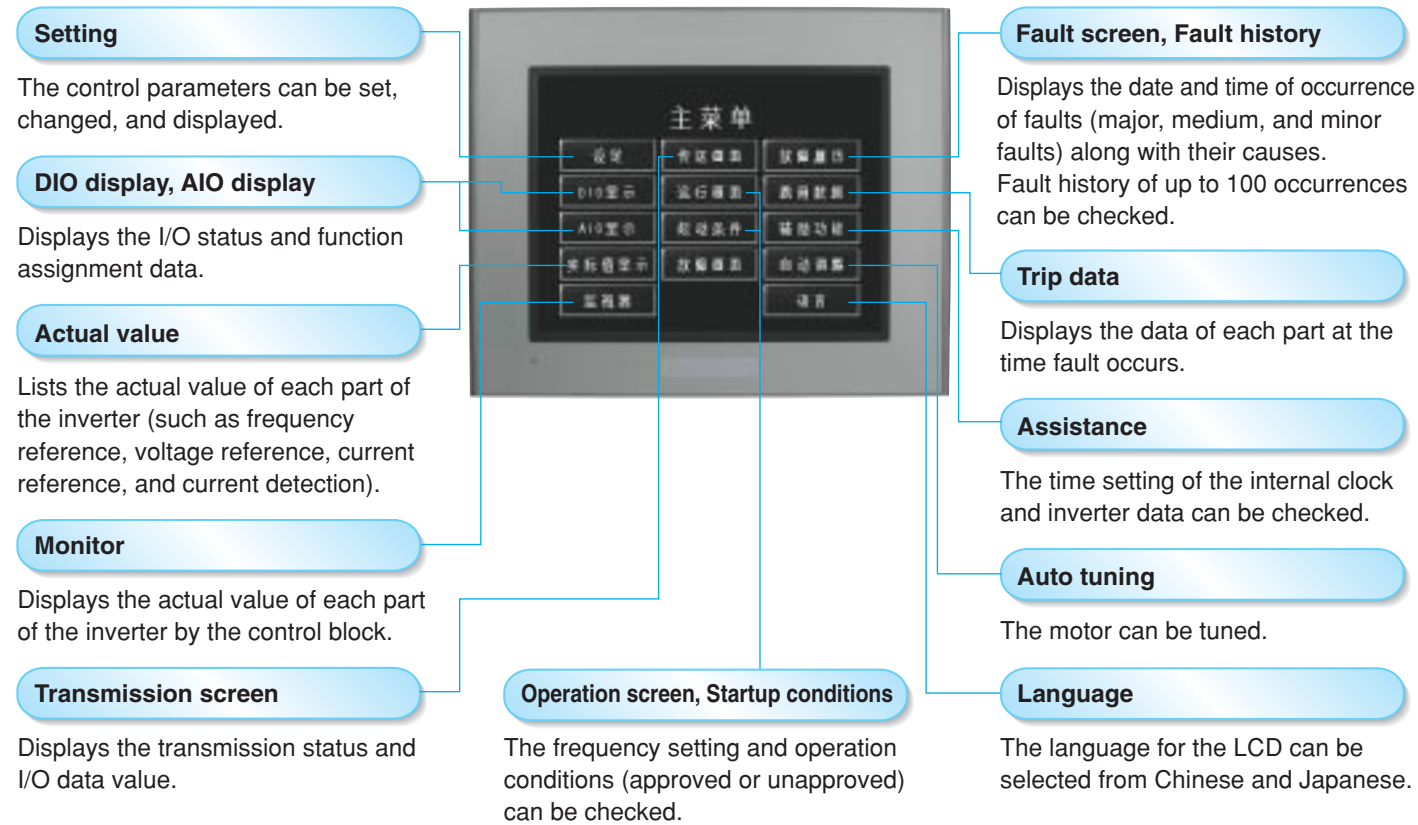

Fig. 6 Power system diagram



Simple operation and monitoring on the 5.7" LCD touch panel



Screen examples



Display description of the touch panel

No.	Description	Number of items
1	Current, voltage and frequency at present (*)	7
2	Parameter setting items	About 320
3	Di/Do status display	7
4	Controller RAM data	About 80
5	Ai/Ao status display	11
6	Sent/received data	About 20
7	Cause of fault	20
8	Present time, operation time	3

(*): Displays 7 items on the 2-image screen.

Other functions

- **Fault history**
Displays a chronological record of 100 faults with the cause and the date and time of occurrence.
- **Trip data display**
Displays the sampling values of internal data and bit data ON/OFF status in the event of a fault.
- **Save of set data, load, and comparison**
The set data can be saved in the EPROM of the touch panel. The saved data can also be loaded and compared with other saved data.

Large LCD touch panel (option)

This is a setting and monitoring tool for facilitating operation and monitoring on a 10.4-inch LCD.

Main functions of LCD touch panel

- Inverter start/stop
- Setting, change and indication of control parameters
- Bar graph display of actual value data
- Indication of fault cause (First fault/detailed indication)
- Trend display
- Test run, etc.



DDC loader for a maintenance tool (option)

Although maintenance and adjustment can be performed from the touch panel mounted on the panel face, an optional DDC loader is available as a maintenance/adjustment tool. The DDC loader using a notebook computer is easy to use because of its interactive mode.

Main functions of maintenance tool

- Setting, change, indication and saving of control parameters
- Running status display
Block diagram display, actual value indication, internal data listing
- Indication of fault cause
First fault, detailed indication, trace-back data
- Test run

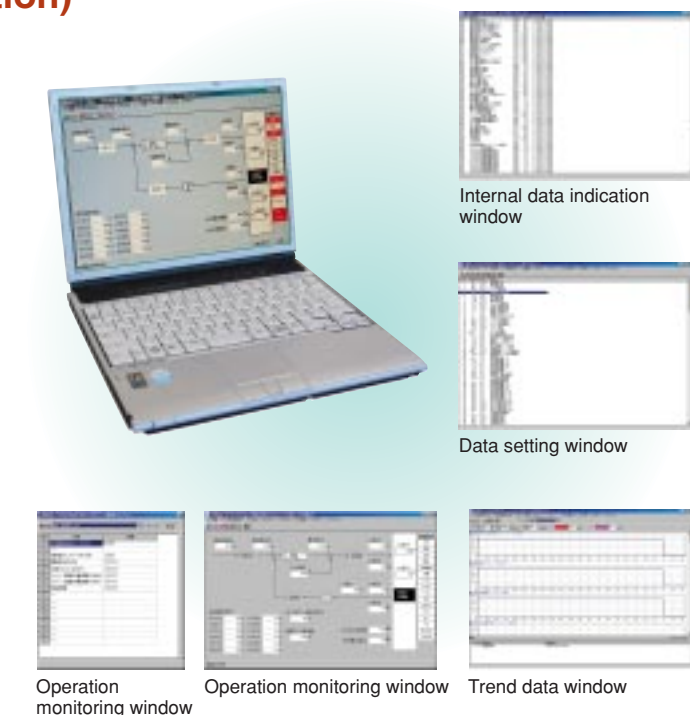

Standard specifications

Fuji product name		FRENIC4600FM5e																						
Voltage classes 10KV	Output	Rated capacity [kVA]	500	620	700	800	900	1040	1200	1350		1470	1700	1850	2030	2350	2600	3050	3500	3700	4000	4600	5300	
		Rated current (*1) [A]	28	35	40	46	51	60	68	77		84	98	106	117	134	150	176	202	213	230	265	306	
		Max. current (at overload) [A]	34	43	48	48	62	70	72	93		101	102	128	138	141	180	208	212	256	277	278	321	
	Applicable max. motor output (*2) [kW]		400	500	560	630	710	800	1000	1120		1250	1400	1500	1600	2000	2240	2500	2800	3000	3150	3550	4000	
	Input	Main circuit (3-phase)	10000V, 50/60Hz																					
		Power supply	Control power supply: single phase, 220V, 50/60Hz, Fan power supply: 3-phase, 380V, 50/60Hz																					
		Capacity of control power supply [kVA]	3.5	3.5	3.5	3.5	3.5	3.5	3.5	3.5		3.5	3.5	3.5	3.5	3.5	3.5	3.5	3.5	3.5	3.5	3.5	3.5	3.5
Capacity of fan power supply [kVA]		4.5	4.5	4.5	4.5	4.5	4.5	4.5	6.0		6.0	6.0	6.0	6.0	6.0	9.0	9.0	9.0	12.0	12.0	12.0	13.5		
Cell control power source		Supplied from AC main circuit (from secondary side of input transformer)																						
Allowable power variation		Voltage: ±10%, Frequency: ±5%																						
Voltage classes 6.6/6KV	Output	Rated capacity [kVA]	470/ 420	570/ 500	670/ 600	780/ 700	960/ 860	1120/ 1000	1320/ 1200	1540/ 1400		1750/ 1600	2000/ 1800	2300/ 2100	2600/ 2360	3036/ 2700	3500/ 3200	4400/ 4000	5200/ 4700	6000/ 5500	7000/ 6400	10500/ 9500		
		Rated current (*1) [A]	41	50	59	68	84	98	115	134		153	173	202	227	265	306	385	459	529	612	918		
		Max. current (at overload) [A]	43	60	70	72	101	102	138	141		183	208	212	273	278	321	462	482	630	643	964		
		Applicable max. motor output (*2) [kW]	370/ 340	450/ 410	530/ 490	630/ 570	760/ 700	900/ 800	1050/ 960	1200/ 1120		1400/ 1280	1600/ 1450	1850/ 1680	2000/ 1900	2400/ 2200	2800/ 2560	3500/ 3200	4160/ 3860	4750/ 4000	5500/ 5140	8300/ 7700		
	Input	Main circuit (3-phase)	6000/6600V, 50/60Hz																					
		Power supply	Control power supply: single phase, 220V, 50/60Hz, Fan power supply: 3-phase, 380V, 50/60Hz																					
		Capacity of control power supply [kVA]	3.5	3.5	3.5	3.5	3.5	3.5	3.5	3.5		3.5	3.5	3.5	3.5	3.5	3.5	6.5	6.5	6.5	6.5	6.5		
Capacity of fan power supply [kVA]		4.5	4.5	4.5	4.5	4.5	4.5	4.5	4.5		6.0	6.0	6.0	9.0	9.0	10.5	12.0	12.0	15.0	15.0	27.0			
Cell control power source		Supplied from AC main circuit (from secondary side of input transformer)																						
Allowable power variation		Voltage: ±10%, Frequency: ±5%																						
Control	Control system		V/f constant with simple sensor-less vector control																					
	Output frequency		Range: 0.2 to 50/60Hz (up to 120Hz as an option), Accuracy: ±0.5% at max. frequency (at analog frequency standard input), Resolution: 0.005%																					
	Accel./decel. time		0.1 to 5500s																					
	Overload capability		105% 60s (*1), 120% for 60s under condition of cold start if cooling fin temperature is less than 40°C.																					
	Main control function		Current limit, stall prevention, jump frequency setting, automatic deceleration, momentary drop protection and stop/restart (option)																					
	Protection function		Overcurrent, main circuit fuse blown, overvoltage, undervoltage, CPU fault, cooling fan stop																					
	Transmission function (option)		T-link, PROFIBUS-DP, Modbus																					
Structure	Panel		Steel panel, self-standing, enclosed, Degree of protection: IP31 (Others: option), Cooling method: forced ventilation with ceiling fan																					
	Finish color		RAL 7032 (inside and outside)																					
Ambient conditions	Temperature		Ambient temp.: 0 to +40°C, Storage temp.: -10 to +60°C, Transport temp.: -10 to +70°C (+60 to +70°C: within 24h)																					
	Humidity		85% RH max. (no condensation)																					
	Installation place		Indoor, Site altitude: up to 1000m above sea level, Acceleration vibration: 4.9m/s² acceptable (10 to 50Hz), Atmosphere: general environment free from corrosive gas, dust and flammable/explosive gas																					
Applicable standard		IEC, JIS, JEM, JEC																						

(*1): The output current is limited when the output frequency is 25Hz or less. (The output current is 70% when the output frequency is 0.2Hz.)

(*2): The applicable motor output is the reference value of Fuji Electric's standard 3, 3.3, 4.16, 6, 6.6kV and 10kV, 4-pole motors.

Notes: 1) Vector control with a speed sensor is available for equipment having high speed and torque accuracy requirements (option).

2) Regenerative braking is not provided.

3) The inverter unit requires a dedicated input breaker.

Standard specifications

Fuji product name		FRENIC4600FM5e										
Voltage classes 4.16KV	Output	Rated capacity [kVA]	300	500	700	830	970	1100	1450	1640	1900	2200
		Rated current (*1) [A]	46	68	98	115	134	153	202	230	265	306
		Max. current (at overload) [A]	48	72	102	138	141	183	212	278	278	321
	Applicable max. motor output (*2) [kW]	245	410	570	680	800	900	1170	1300	1500	1730	
	Input	Main circuit (3-phase)	4160V, 50/60Hz									
		Power supply	Control power supply: single phase, 220V, 50/60Hz, Fan power supply: 3-phase, 380V, 50/60Hz									
Capacity of control power supply [kVA]		3.5	3.5	3.5	3.5	3.5	3.5	3.5	3.5	3.5	3.5	
Capacity of fan power supply [kVA]		4.5	4.5	4.5	4.5	4.5	4.5	4.5	6.0	6.0	7.5	
Cell control power source		Supplied from AC main circuit (from secondary side of input transformer)										
Allowable power variation		Voltage: ±10%, Frequency: ±5%										
Voltage classes 3.3/3KV	Output	Rated capacity [kVA]	390/350	560/500	770/700	1150/1050	1500/1350	1750/1600	2600/2350	3500/3200	5200/4750	
		Rated current (*1) [A]	68	98	135	202	262	306	460	612	918	
		Max. current (at overload) [A]	72	103	141	212	275	321	482	643	964	
	Applicable max. motor output (*2) [kW]	315/285	450/400	610/560	920/840	1200/1100	1400/1280	2100/1930	2800/2570	4200/3850		
	Input	Main circuit (3-phase)	3000/3300V, 50/60Hz									
		Power supply	Control power supply: single phase, 220V, 50/60Hz, Fan power supply: 3-phase, 380V, 50/60Hz									
Capacity of control power supply [kVA]		Contact us for details.										
Capacity of fan power supply [kVA]		Contact us for details.										
Cell control power source		Supplied from AC main circuit (from secondary side of input transformer)										
Allowable power variation		Voltage: ±10%, Frequency: ±5%										
Control	Control system	V/f constant with simple sensor-less vector control										
	Output frequency	Range: 0.2 to 50/60Hz (up to 120Hz as an option), Accuracy: ±0.5% at max. frequency (at analog frequency standard input), Resolution: 0.005%										
	Accel./decel. time	0.1 to 5500s										
	Overload capability	105% 60s (*1), 120% for 60s under condition of cold start if cooling fin temperature is less than 40°C.										
	Main control function	Current limit, stall prevention, jump frequency setting, automatic deceleration, momentary drop protection and stop/restart (option)										
	Protection function	Overcurrent, main circuit fuse blown, overvoltage, undervoltage, CPU fault, cooling fan stop										
Transmission function (option)	T-link, PROFIBUS-DP, Modbus											
Structure	Panel	Steel panel, self-standing, enclosed, Degree of protection: IP31 (Others: option), Cooling method: forced ventilation with ceiling fan										
	Finish color	RAL 7032 (inside and outside)										
Ambient conditions	Temperature	Ambient temp.: 0 to +40°C, Storage temp.: -10 to +60°C, Transport temp.: -10 to +70°C (+60 to +70°C: within 24h)										
	Humidity	85% RH max. (no condensation)										
	Installation place	Indoor, Site altitude: up to 1000m above sea level, Acceleration vibration: 4.9m/s² acceptable (10 to 50Hz), Atmosphere: general environment free from corrosive gas, dust and flammable/explosive gas										
Applicable standard	IEC, JIS, JEM, JEC											

(*1): The output current is limited when the output frequency is 25Hz or less. (The output current is 70% when the output frequency is 0.2Hz.)

(*2): The applicable motor output is the reference value of Fuji Electric's standard 3, 3.3, 4.16, 6, 6.6kV and 10kV, 4-pole motors.

Notes: 1) Vector control with a speed sensor is available for equipment having high speed and torque accuracy requirements (option).

2) Regenerative braking is not provided.

3) The inverter unit requires a dedicated input breaker.

Standard connection diagram

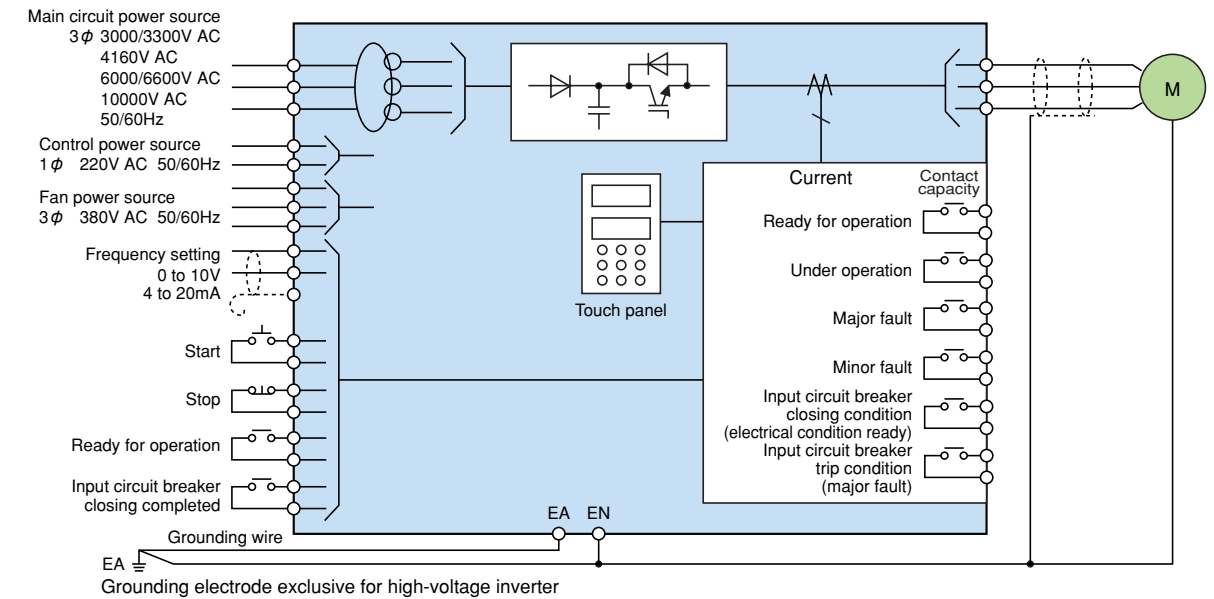

Note: Be sure to use an EA grounding electrode exclusive for the high-voltage inverter, and isolate it from the main grounding lines of other devices.

Standard interface

Input side		
Main circuit power supply	3-phase 3000/3300/4160/6000/6600/10000V, 50/60Hz	
Control power supply	Single phase 220V, 50/60Hz	
Fan power supply	3-phase 380V, 50/60Hz	
Frequency setting	0 to 10V/0 to 100% or 4 to 20mA/0 to 100%	Input impedance 1MΩ Input impedance 250Ω
Run command	Closure for run ("a" contact)	Dry contact
Stop command	Opening for stop ("b" contact)	
Ready for operation	Closure when ready ("a" contact)	
Input circuit breaker status signal	Closure when closed ("a" contact)	
Output side		
Electrical condition ready	Closure when ready ("a" contact)	Dry contact
Under operation	Closure under operation ("a" contact)	(contact capacity: 250V AC, 2A or 30V DC, 3A)
Major fault	Closure at major fault ("a" contact)	
Minor fault	Closure at minor fault ("a" contact)	
Input circuit breaker closing condition	Closure when electrical condition ready ("a" contact)	
Input circuit breaker trip signal	Closure in major fault ("a" contact)	
Analog signal (option) (*)	0 to 10V 4 to 20mA	Load resistance 10kΩ or more Load resistance 750Ω or less

(*): The analog output signal is selectable (output current, output voltage, output frequency, and others).

Dimensions

10kV								
Capacity [kVA]	Outline drawing	Dimension [mm]						Approx. mass [kg]
		A (Full width)	B (Transformer panel)	C (Converter panel)	D (Control output panel)	E (Fan)	F (Depth)	G (Maintenance space)
500, 620, 700, 800	Fig. 1	4300	2500	1800	—	535	1400	1500
900, 1040, 1200		4300	2500	1800	—	535	1400	1500
1350, 1470, 1700	Fig. 2	5100	2700	2400	—	535	1500	1500
1850, 2030, 2350		5100	2700	2400	—	535	1500	1500
2600, 3050, 3500	Fig. 3	6000	3000	3000	—	375	1600	1700
3700, 4000, 4600	Fig. 4	6900	2700	3600	600	600	1700	1700
5300		7600	2800	4200	600	600	1800	1700

Notes: (*1) The panel configurations shown above are typical examples. They may differ depending on the capacity.
 (*2) The structure is for maintenance from the front. Be sure to allow the maintenance space listed in column G of the above table or more.
 (*3) A cooling fan is installed on the panel. To facilitate maintenance and ensure cooling performance, allow designated space (Min. 500mm) between the top face of the fan and the ceiling.
 (*4) The outline dimensions of the panel may be changed without notice. Contact us for details.

10kV series

Fig. 1 10kV: 500, 620, 700, 800, 900, 1040, 1200kVA

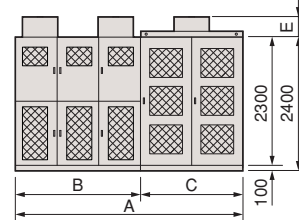

Fig. 2 10kV: 1350, 1470, 1700, 1850, 2030, 2350kVA

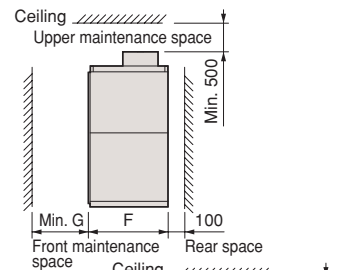
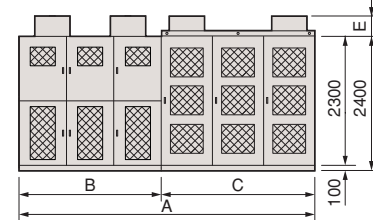

Fig. 3 10kV: 2600, 3050, 3500kVA

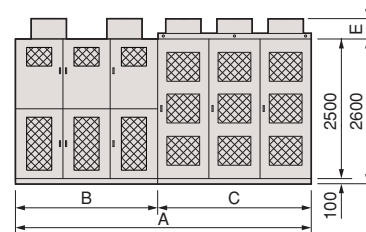
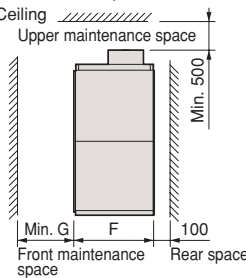
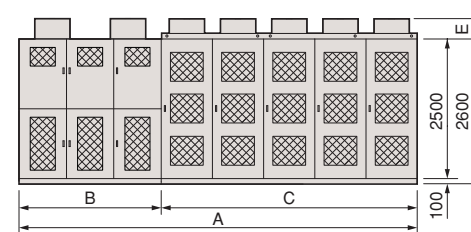

Fig. 4 10kV: 3700, 4000, 4600, 5300kVA



6kV								
Capacity [kVA]	Outline drawing	Dimension [mm]						Approx. mass [kg]
		A (Full width)	B (Transformer panel)	C (Converter panel)	D (Control output panel)	E (Fan)	F (Depth)	G (Maintenance space)
420, 500, 600, 700	Fig. 5	3000	1900	1000	—	426	1300	1500
860, 1000	Fig. 6	3400	2000	1400	—	426	1400	1500
1200, 1400	Fig. 7	3500	2100	1400	—	426	1400	1500
1600, 1800, 2100	Fig. 8	4000	2300	1700	—	426	1500	1700
2360, 2700	Fig. 9	4500	2300	2200	—	662	1600	1700
3200	Fig. 10	4900	2500	2400	—	662	1700	1700
4000	Fig. 11	8400	2300	1400	1000	570	1500	1500
4700		8400	2300	1400	1000	570	1500	1500
5500	Fig. 12	12900	2400	3600	900	570	1400	1500
6400		12900	2400	3600	900	570	1400	1500
9500	Fig. 13	20800	5000	4800	1000	375	1900	1800

Notes: (*1) The panel configurations shown above are typical examples. They may differ depending on the capacity.
 (*2) The structure is for maintenance from the front. Be sure to allow the maintenance space listed in column G of the above table or more (Figs. 11 to 13: Front/rear maintenance structure).
 (*3) A cooling fan is installed on the panel. To facilitate maintenance and ensure cooling performance, allow designated space (Min. 500mm) between the top face of the fan and the ceiling.
 (*4) A wiring duct is installed on the panel in Fig. 13 (height: 600mm).
 (*5) The outline dimensions of the panel may be changed without notice. Contact us for details.

6kV series

Front maintenance structure

Fig. 5 6kV: 420, 500, 600, 700kVA

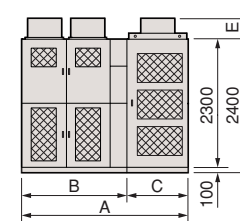

Fig. 6 6kV: 860, 1000kVA

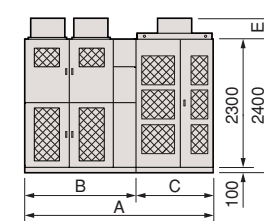

Fig. 7 6kV: 1200, 1400kVA

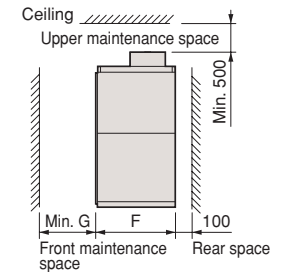
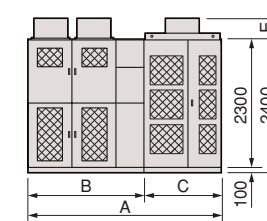

Fig. 8 6kV: 1600, 1800, 2100kVA

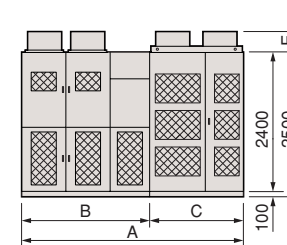

Fig. 9 6kV: 2360, 2700kVA

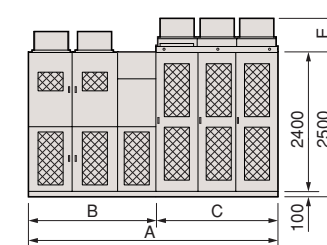
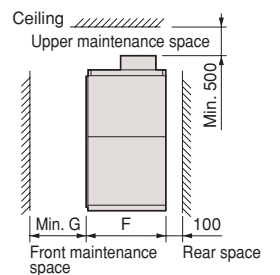
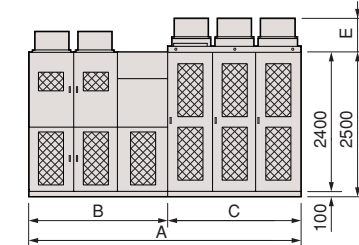

Fig. 10 6kV: 3200kVA



Front/rear maintenance structure

Fig. 11 6kV: 4000, 4700kVA

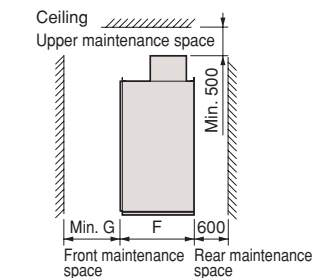
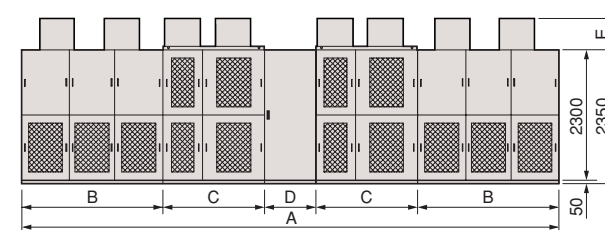

Fig. 12 6kV: 5500, 6400kVA

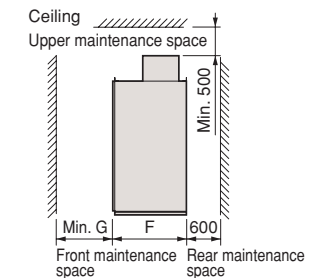
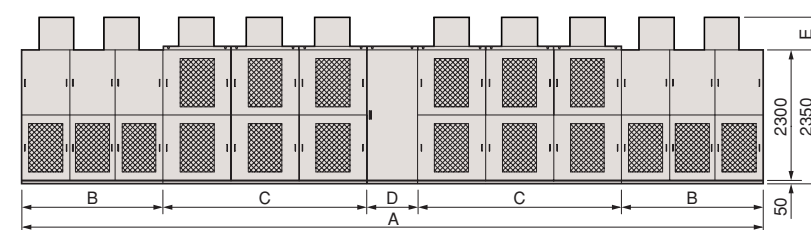
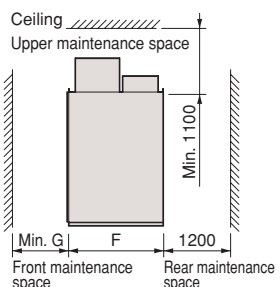
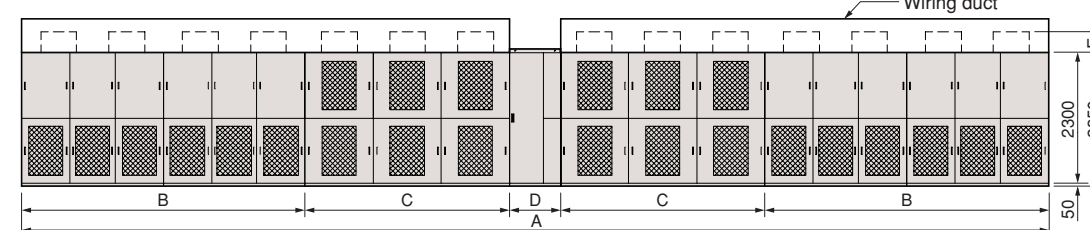

Fig. 13 6kV: 9500kVA



Dimensions

4.16kV									
Capacity [kVA]	Outline drawing	Dimension [mm]							Approx. mass [kg]
		A (Full width)	B (Transformer panel)	C (Converter panel)	D (Control output panel)	E (Fan)	F (Depth)	G (Maintenance space)	
300	Fig. 14	2800	1900	900	—	426	1300	1500	3300
500		2800	1900	900	—	426	1300	1500	3700
700		3000	2000	1000	—	426	1400	1500	4600
830		3100	2100	1000	—	426	1400	1500	4900
970		3100	2100	1000	—	426	1400	1500	5300
1100	Fig. 15	3500	2300	1200	—	426	1500	1500	5600
1450		3500	2300	1200	—	426	1500	1500	6400
1640	Fig. 16	3800	2300	1500	—	662	1600	1700	7000
1900		3800	2300	1500	—	662	1600	1700	7500
2200		4100	2500	1600	—	662	1700	1700	8600

Notes: (*1) The panel configurations shown above are typical examples. They may differ depending on the capacity.
 (*2) The structure is for maintenance from the front. Be sure to allow the maintenance space listed in column G of the above table or more.
 (*3) A cooling fan is installed on the panel. To facilitate maintenance and ensure cooling performance, allow designated space (Min. 500mm) between the top face of the fan and the ceiling.
 (*4) The outline dimensions of the panel may be changed without notice. Contact us for details.

4.16kV series

Fig. 14 4.16kV: 300, 500, 700, 830, 900, 970kVA

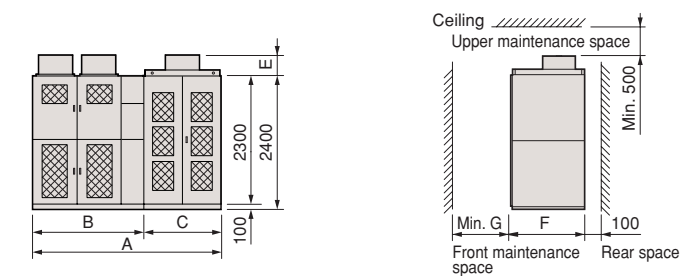

Fig. 15 4.16kV: 1100, 1450kVA

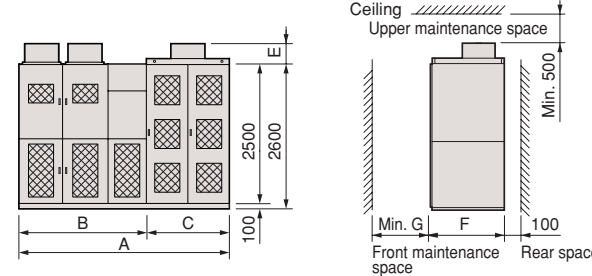
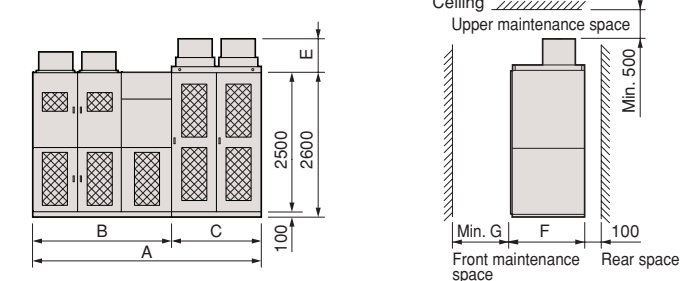

Fig. 16 4.16kV: 1640, 1900, 2200kVA



3kV									
Capacity [kVA]	Outline drawing	Dimension [mm]							Approx. mass [kg]
		A (Full width)	B (Transformer panel)	C (Converter panel)	D (Control output panel)	E (Fan)	F (Depth)	G (Maintenance space)	
350	Fig. 17	2000	—	—	—	543	1000	1300	2500
500	Fig. 18	2300	—	—	—	543	1100	1300	3000
700	Fig. 19	2300	—	—	—	605	1200	1300	4100
1050	Fig. 20	3000	2100	900	—	372	1300	1300	4500
1350	Fig. 21	3400	2300	1100	—	542	1400	1300	6200
1600	Fig. 22	3500	2300	1200	—	542	1400	1300	7000
2350	Fig. 23	3800	2400	1400	—	542	1500	1500	8300
3200	Fig. 24	6800	2300	3600	900	542	1400	1500	12300
4750	Fig. 25	10900	5200	4800	900	600	1900	1800	26000

Notes: (*1) The panel configurations shown above are typical examples. They may differ depending on the capacity.
 (*2) The structure is for maintenance from the front. Be sure to allow the maintenance space listed in column G of the above table or more (Figs. 24 and 25: Front/rear maintenance structure).
 (*3) A cooling fan is installed on the panel. To facilitate maintenance and ensure cooling performance, allow designated space (Min. 500mm) between the top face of the fan and the ceiling.
 (*4) A wiring duct is installed on the panel in Fig. 25 (height: 600mm).
 (*5) The outline dimensions of the panel may be changed without notice. Contact us for details.

3kV series

Front maintenance structure

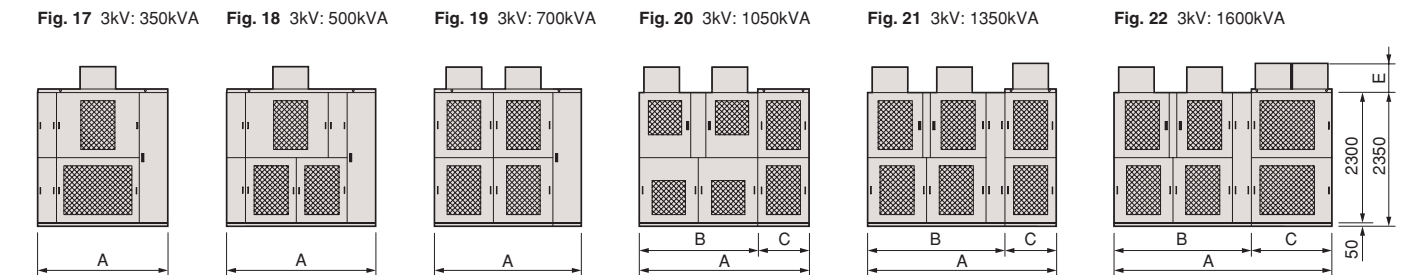

Front/rear maintenance structure

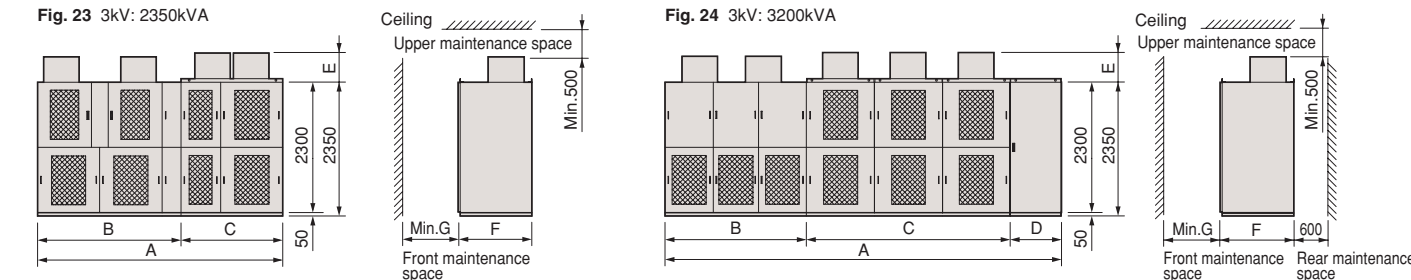
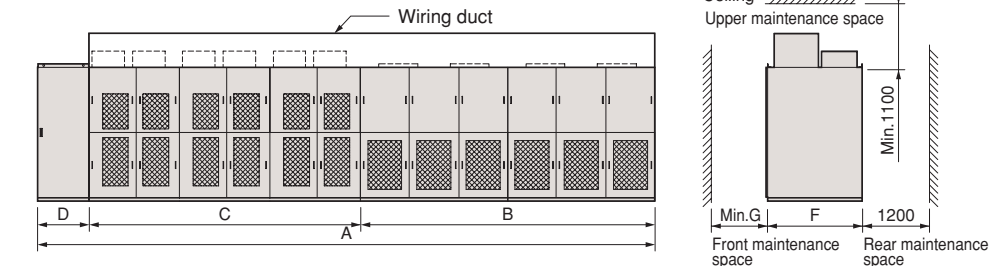

Fig. 25 3kV: 4750kVA



FRENIC4600FM5e inverter operation promises substantial energy-saving and carbon dioxide reduction.

In air-conditioning or pumping facilities, fans or pumps typically run at a constant speed even when the load is light. Adjustable speed control according to the load (air or liquid flow) through inverter operation greatly reduces energy consumption and maintains the maximum possible motor efficiency even at low-speed operation.

Liquid flow and power characteristics

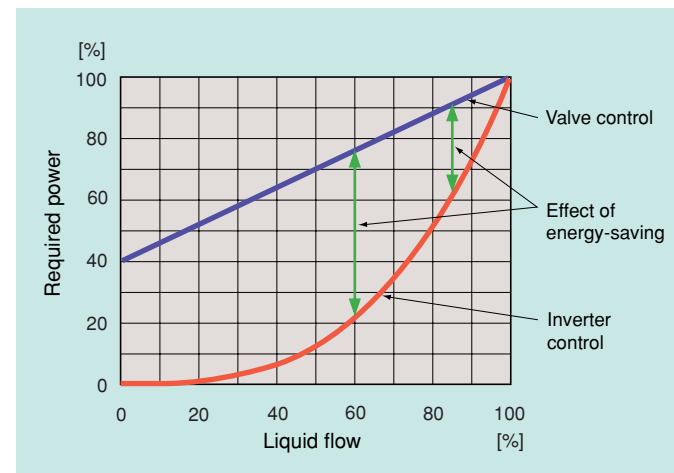

Example of application and energy-saving effect

The following example compares constant speed motor operation with valve (or damper) control, against inverter adjustable speed control operation, and shows the electric power saved.

● Example conditions for calculation

Motor output:
1,000kW, for annual operation time 4,000 hours
Operation pattern:
85% flow for 1/2 of overall time (2,000 hours)
60% flow for the remaining half (2,000 hours)

● Constant speed operation of motor (with valve control)

At 85% load of liquid flow (Q)
Required Power (P) = 91% × 1,000kW = 910kW
At 60% load of liquid flow (Q)
Required Power (P) = 76% × 1,000kW = 760kW
Annual power consumption
910kW × 2,000h + 760kW × 2,000h = 3,340,000kWh

● Inverter operation (adjustable speed control operation with inverter)

At 85% load of liquid flow (Q)
Required Power (P) = 61% × 1,000kW = 610kW
At 60% load of liquid flow (Q)
Required Power (P) = 22% × 1,000kW = 220kW
Annual power consumption
610kW × 2,000h + 220kW × 2,000h = 1,660,000kWh

● Annual energy-saving

3,340,000 - 1,660,000 = 1,680,000kWh
(energy-saving = about 50%)
Carbon dioxide reduction = 635,040kg

Options

Field Web adapter (plusFSITE)



plusFSITE

This adapter enables users to carry out remote monitoring of inverters promptly and easily with their own personal computers without using a dedicated system.

Main features

- Web server function
Inverters can be monitored from the browser of a personal computer. (Display screen can be changed if requested.)
- Mail sending function
Actions can be reported periodically from inverters.
- Installation and wiring both easy
 - A small and lightweight structure mountable on the front of the inverter panel
 - Connectable with the loader connector of an inverter (RS-232C interface)
 - Connectable with personal computers through LAN cable (IEEE802.3 10BASE-T)
- Equipped with a 32-bit RISC chip/real-time OS μITRON
- Protocol converting function
(Changeable from RS-232C to LAN)
- The corresponding drive unit is applicable to the FRENIC4600FM5e and other products of Fuji Electric.

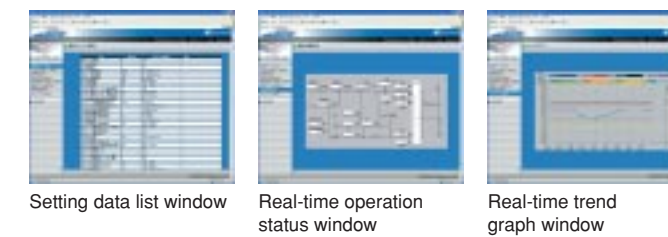

LCD touch panel

The touch panel offers the following key loader functions:

- Start and stop of inverter
- Setting, change and display of control parameters
- Fault data display and fault resetting
- Data monitoring (LED display)

The contents of the above data are displayed on the LCD.

DDC loader

A loader using a notebook personal computer is available. The easy-to-use interactive type of loader offers the following functions.

- Start and stop of inverter
- Online setting, change, display and printing of control parameters
- Fault resetting
- Trace-back data
- Fault data display and printing
- Data monitoring

Analog output unit (AO unit)

Data can be output in analog mode during operation. Output data can be freely selectable among about 100 items by operating the touch panel.

Lifter

A special lifter for drawing out inverter cells

Application	Series	Features	Output voltage [V]	Capacity range [kVA]			
				10	100	1000	10000
For plant	FRENIC 4000VM5	Vector controlled inverter for plants • High-performance vector control system for quick response, high-accuracy and wide range speed control. • The DC-link system allows highly efficient plant operation.	400				5400
	FRENIC 4000FM5	V/f controlled inverter for plants • Frequency of fan, pump and group-driven motors can be controlled accurately. • The DC-link system allows highly efficient plant operation.	400				900
	FRENIC 4400VM5	Large-capacity vector controlled inverter • The capacity of FRENIC4000 series units has been increased due to 3-level control.	800				6000
	FRENIC 4400FM5	Large-capacity V/f controlled inverter • The capacity of FRENIC4000 series units has been increased due to 3-level control.	800				2000
	FRENIC 4700VM5	Medium-voltage large-capacity vector controlled inverter • The capacity of FRENIC4000 series units has been increased thanks to the series-connected device and 3-level control.	3440				7800
	FRENIC 4800VM5	Medium-voltage, water-cooling, large-capacity and vector controlled inverter • The capacity of FRENIC4000 series units has been increased due to 3-level control. • Downsizing achieved by adopting a water-cooling system	3100				24000
For general industry (medium-voltage)	FRENIC 4600FM5	Medium-voltage direct-output inverter • 3.3/6.6kV IGBT inverter • Variable speed operation of medium-voltage motors saves energy. • Circuit configuration and control are well designed for power supplies and motors.	3300				3750
			6600				7500
	FRENIC 4600FM5e	Medium-voltage direct-output inverter (for fans and pumps) • Compact • Variable speed operation of medium-voltage motors saves energy. • Circuit configuration and control are well designed for power supplies and motors.	3000/3300 4160 6000/6600 10000				4750/ 5200 2200 9500/ 10500 5300
For general industry (low-voltage)	FRENIC-VG	High-performance vector controlled inverter	200 400				90kW 800kW
	FRENIC-MEGA	High-performance V/f controlled inverter	200 400				90kW 630kW
	FRENIC-ECO	V/f controlled inverter for fans and pumps	200				110kW
			400				560kW

Selection of inverter capacity

When selecting inverter capacity, select an inverter whose rated current value is larger than the operating current of the motor to be driven.

● Selection example 1

For driving a 6kV, 50Hz, 315kW, 4-pole motor:
Rated current value of motor: 38A
Operating current value of motor: 38A
→ Select an inverter capacity of 420kVA (41A).
(38 < 41A)

● Selection example 2

For driving a 6kV, 50Hz, 630kW, 4-pole motor:
Rated current value of motor: 75A
Operating current value of motor: 56A
→ Select an inverter capacity of 600kVA (59A).
(56 < 59A)

Examples of applications

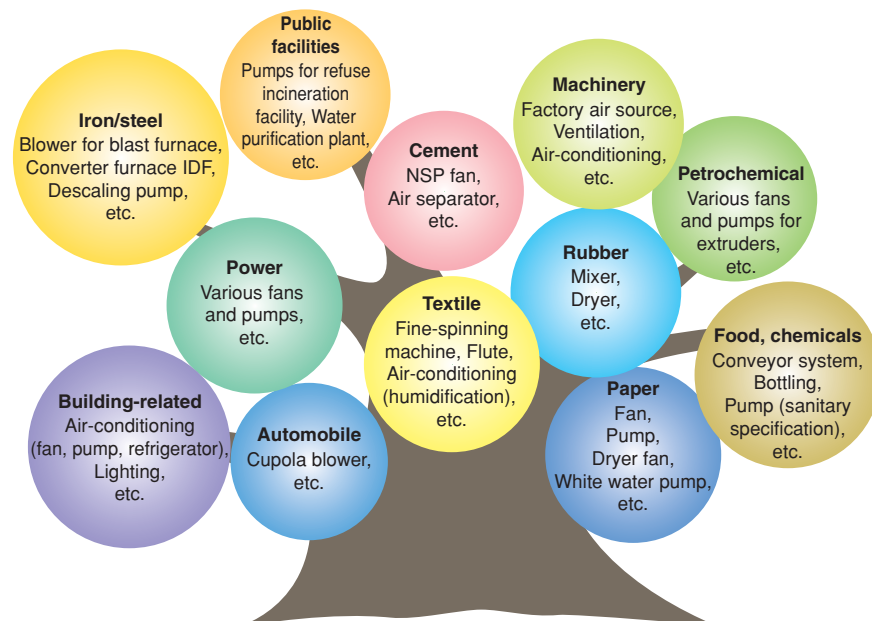

FRENIC4600FM5e (6.6kV 10,500kVA(*))



(*): Max. capacity of this model

Ordering Information

When placing an order or making an inquiry, please state the following.

Application of inverter		Remarks:	
Load machine specifications			
Name: <input type="checkbox"/> Pump, <input type="checkbox"/> Fan, <input type="checkbox"/> Blower, <input type="checkbox"/> Air compressor, <input type="checkbox"/> Other ()			
Load torque characteristics: <input type="checkbox"/> Square-law speed, <input type="checkbox"/> Constant torque, <input type="checkbox"/> Constant output			
Moment of load inertia after conversion into motor shaft (J):			kg · m ²
Overload: %			
Input specifications			
Rated voltage: V±		% Rated frequency: Hz± %	
Control power source: -phase, -wires, V, Hz			
Drive motor			
Motor specifications: <input type="checkbox"/> Squirrel-cage rotor, <input type="checkbox"/> (), <input type="checkbox"/> Existing, <input type="checkbox"/> New installation			
Rating	Output: kW	No. of poles:	Voltage: kV
	Frequency: Hz	Speed: r/min	Current: A
Speed control			
Controllable range: r/min to r/min			
Rotational frequency setting method			
<input type="checkbox"/> Analog signal: 4 to 20mA, 0 to 10V, <input type="checkbox"/> Up/down signal, <input type="checkbox"/> ()			
Commercial power source bypass circuit			
<input type="checkbox"/> with, <input type="checkbox"/> without			
Ambient conditions			
Install location: Indoor	Humidity: %RH	Temperature: °C	Altitude: m
Provision of air conditioning:		Limit on carrying-in:	



认证注册号

ISO9001 : 00106Q116927R3M/3200
ISO14001: 00108E20998R1M/3200

认证注册号

00106Q116927R3M/3200
00108E20998R1M/3200

体系认证

CNAS C001-Q
CNAS C001-E

Our factories in China, where this instrument is manufactured, are ISO 9001 and ISO 14001 certified.

Printed on recycled paper

Fuji Electric Co., Ltd.

Gate City Ohsaki, East Tower, 11-2, Osaki 1-chome, Shinagawa-ku, Tokyo 141-0032, Japan
Phone : (03)5435-7111

Internet address : <http://www.fujielectric.co.jp>

Information in this catalog is subject to change without notice.

2011-8(H2011b/B2010)KO-D/CTP20k Printed in Japan